



The MX2000-LN series are intensity modulators especially designed for operation in the 2.0 μ m wavelength band at frequencies up to 10 GHz and above.

These Mach-Zehnder modulators offer engineers working at 2.0 μ m the intrinsic and unparalleled benefits of LiNbO₃ external modulation : high bandwidth , high contrast, ease of use.

The MX2000-LN series are based on a X-cut design that confers them an unparalleled stability. They incorporate 2.0 μ m specific waveguide and are pigtailed with 2.0 μ m polarization maintaining fibers.

FEATURES

- Low insertion loss
- Low V_{π}
- 2 μ m specific design

APPLICATIONS

- LIDAR
- Gas sensing
- Mid-IR wavelength generation
- Spectroscopy
- Seed source
- Research & development

OPTIONS

- 20 GHz version
- Hermetic sealing

RELATED EQUIPMENTS

- Choice of RF drivers
- 2.0 μ m band Phase Modulators
- MBC-DG Automatic Bias Controllers

MX2000-LN-01 Performance Highlights

Parameter	Min	Typ	Max	Unit
Operating wavelength	1900	-	2200	nm
Insertion loss	-	4	-	dB
Electro-optical bandwidth	1	2	-	GHz
V_{π} RF @50 kHz	-	5.5	-	V

Specifications given at 25 °C, 50 Ω , 2050 nm

MX2000-LN-10 Performance Highlights

Parameter	Min	Typ	Max	Unit
Operating wavelength	1900	-	2200	nm
Insertion loss	-	4	-	dB
Electro-optical bandwidth	10	12	-	GHz
V_{π} RF @50 kHz	-	9.5	-	V

Specifications given at 25 °C, 50 Ω , 2050 nm

MX2000-LN-01
1 GHz Intensity Modulator
Electrical Characteristics 50 Ω RF input

Parameter	Symbol	Condition	Min	Typ	Max	Unit
Electro-optic bandwidth	S_{21}	RF electrodes, from 500 MHz	1	2	-	GHz
Ripple S21	ΔS_{21}	RF electrodes, $f < 2$ GHz	-	0.5	1	dB
Electrical return loss	ES_{11}	RF electrodes, $f < 2$ GHz	-	-12	-10	dB
$V\pi$ RF @50 kHz	$V\pi_{RF_{50\text{ kHz}}}$	RF electrodes	-	5.5	6.5	V
$V\pi$ DC electrodes	$V\pi_{DC}$	DC electrodes	-	11.5	13	V
RF input impedance	Z_{in-RF}	-	-	40	-	Ω
DC input impedance	Z_{in-DC}	-	-	1	-	MΩ

Optical Characteristics All specifications given at 25°C, 2050 nm, unless differently specified

Parameter	Symbol	Condition	Min	Typ	Max	Unit
Crystal	-	-	Lithium Niobate X-Cut Y-Prop			
Operating wavelength	λ	-	1900	2050	2200	nm
Insertion loss	IL	Without connectors	-	4	5.5	dB
DC extinction ratio	ER	Measured with narrow source linewidth < 200 MHz	20	22	-	dB
Optical return loss	ORL	-	-40	-45	-	dB
Chirp	α	-	-0.1	0	0.1	-

Absolute Maximum Ratings

Stresses in excess of the absolute maximum ratings can cause permanent damage to the device. These are absolute stress ratings only. Functional operation of the device is not implied at these or any other conditions in excess of those given in the operational sections of the data sheet. Exposure to absolute maximum ratings for extended periods can adversely affect device reliability.

Parameter	Symbol	Min	Max	Unit
RF input power	EP_{in}	-	28	dBm
Bias voltage	V_{bias}	-20	+20	V
Optical input power	OP_{in}	-	20	dBm
Operating temperature	OT	0	+70	°C
Storage temperature	ST	-40	+85	°C

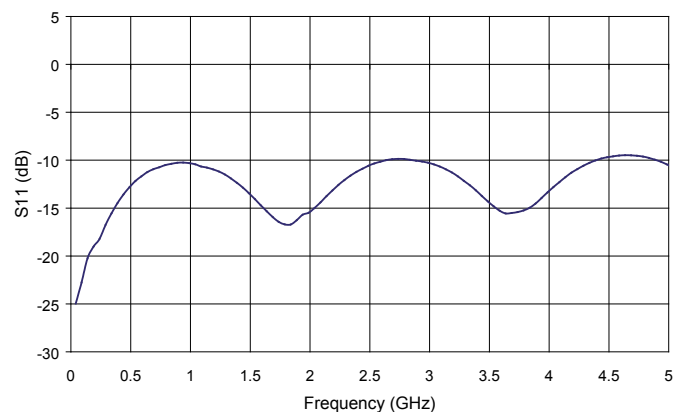
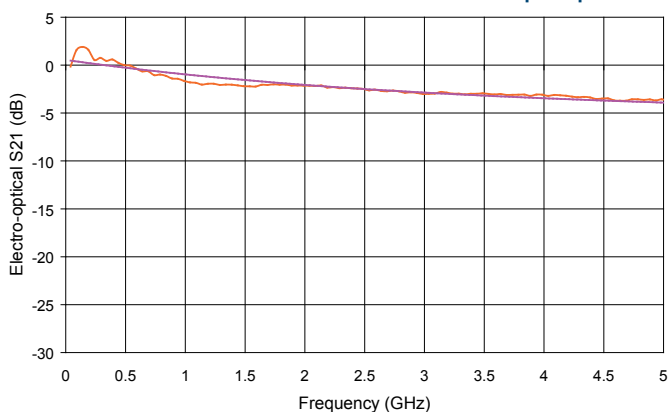
S21 & S11 Parameter Curves at RF input port

MX2000-LN-10
10 GHz Intensity Modulator
Electrical Characteristics 50 Ω RF input

Parameter	Symbol	Condition	Min	Typ	Max	Unit
Electro-optic bandwidth	S_{21}	RF electrodes, from 2 MHz	10	12	-	GHz
Ripple S21	ΔS_{21}	RF electrodes, $f < 2$ GHz	-	0.5	1	dB
Electrical return loss	ES_{11}	RF electrodes, $f < 10$ GHz	-	-12	-10	dB
$V\pi$ RF @50 kHz	$V\pi_{RF_{50\text{ kHz}}}$	RF electrodes	-	9.5	11	V
$V\pi$ DC electrodes	$V\pi_{DC}$	DC electrodes	-	11	13	V
RF input impedance	Z_{in-RF}	-	-	40	-	Ω
DC input impedance	Z_{in-DC}	-	-	1	-	M Ω

Optical Characteristics All specifications given at 25°C, 2050 nm, unless differently specified

Parameter	Symbol	Condition	Min	Typ	Max	Unit
Crystal	-	-	Lithium Niobate X-Cut Y-Prop			
Operating wavelength	λ	-	1900	2050	2200	nm
Insertion loss	IL	Without connectors	-	4	5.5	dB
DC extinction ratio	ER	Measured with narrow source linewidth < 200 MHz	20	22	-	dB
Optical return loss	ORL	-	-40	-45	-	dB
Chirp	α	-	-0.1	0	0.1	-

Absolute Maximum Ratings

Stresses in excess of the absolute maximum ratings can cause permanent damage to the device. These are absolute stress ratings only. Functional operation of the device is not implied at these or any other conditions in excess of those given in the operational sections of the data sheet. Exposure to absolute maximum ratings for extended periods can adversely affect device reliability.

Parameter	Symbol	Min	Max	Unit
RF input power	EP_{in}	-	28	dBm
Bias voltage	V_{bias}	-20	+20	V
Optical input power	OP_{in}	-	20	dBm
Operating temperature	OT	0	+70	$^{\circ}\text{C}$
Storage temperature	ST	-40	+85	$^{\circ}\text{C}$

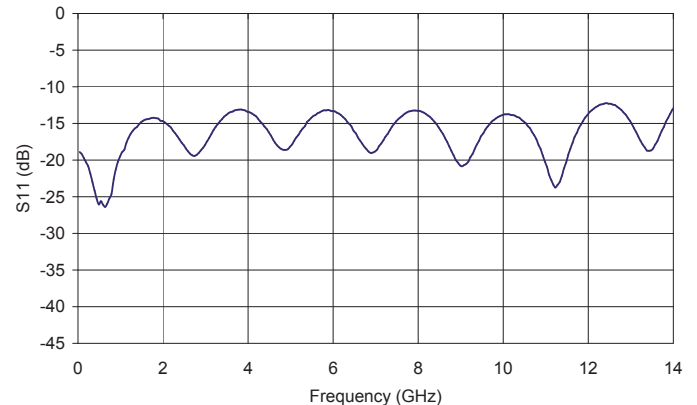
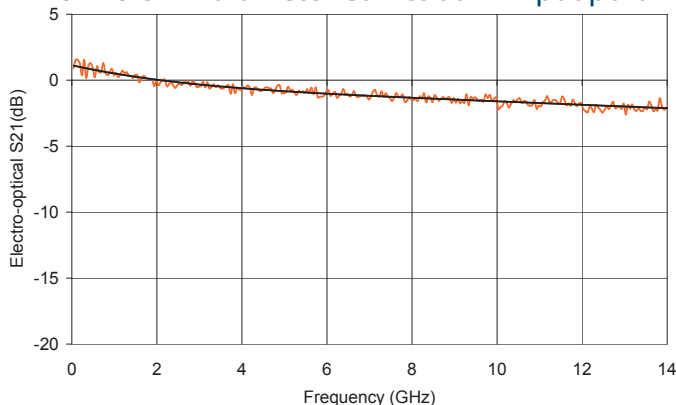
S21 & S11 Parameter Curves at RF input port

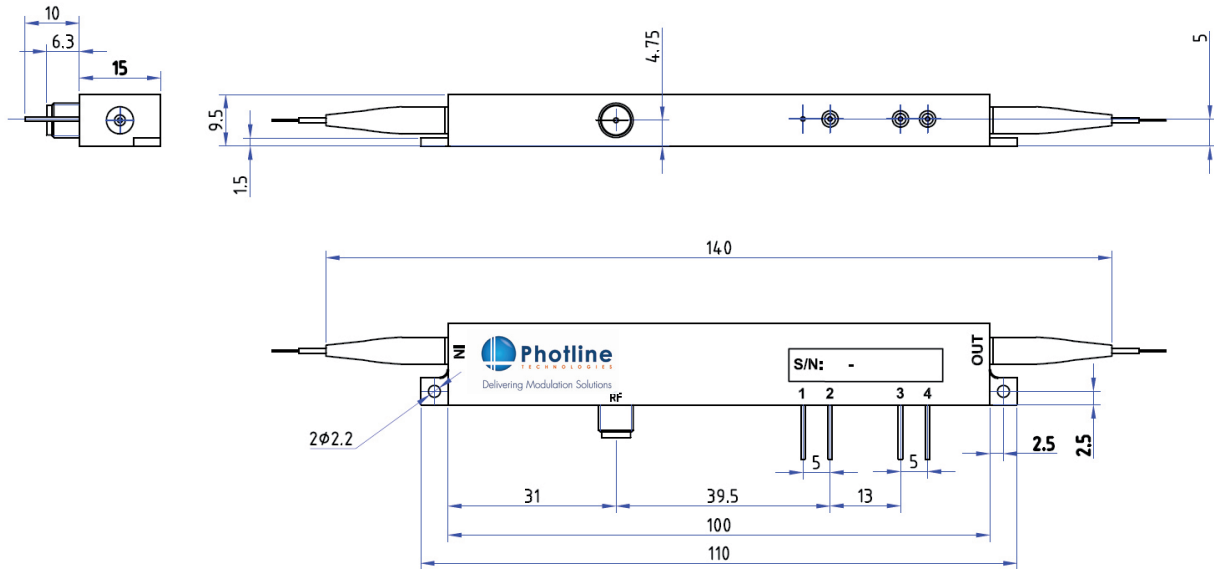
Mechanical Diagram and Pinout All measurements in mm

Port	Function	Note
IN	Optical input port	2000 nm Polarization maintaining fiber, Nufern PM1950 length : 1.5 meter
OUT	Optical output port	2000 nm Polarization maintaining fiber, Nufern PM1950 length : 1.5 meter
RF	RF input port	Wiltron female K (SMA compatible)
1	Ground	Pin feed through diameter 1.0 mm
2	DC	Pin feed through diameter 1.0 mm
3	Photodiode cathode	Pin feed through diameter 1.0 mm
4	Photodiode anode	Pin feed through diameter 1.0 mm

Ordering information
MX2000-LN-BW-XX-Y-Z-AB-CD

BW = Bandwidth : 01 1 GHz 10 10 GHz

XX = Internal photodiode : 00 Not integrated PD PD Integrated

Y = Input fiber : P Polarisation maintaining S Standard single mode

Z = Input fiber : P Polarisation maintaining S Standard single mode

AB = Output connector : 00 bare fiber FA FC/APC FC FC/SPC

CD = Output connector : 00 bare fiber FA FC/APC FC FC/SPC

Note : optical connectors are Seikoh-Giken with narrow key or equivalent

Related equipments

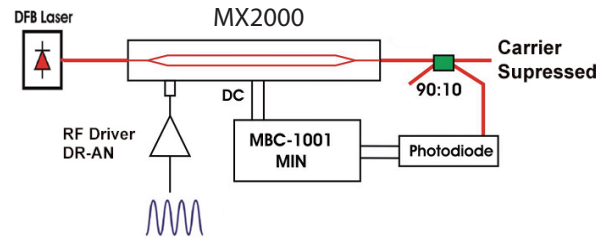
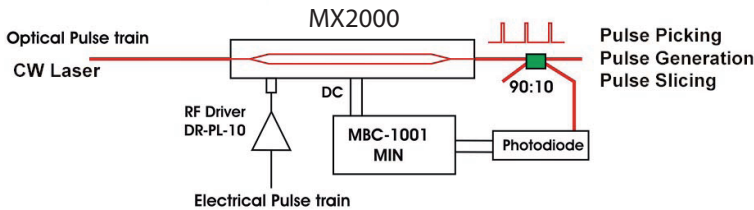

Pulse Generation / Picking / Slicing

DR-PL series amplifiers are designed to drive MX2000-LN modulators so as to generate undistorted optical pulses.



MBC-DG-BT is an automatic bias controller that locks the operating point of the MX2000-LN modulators. When paired with the proper modulator, MBC-DG-BT can achieve an extinction ratio up to 50 dB.



Carrier suppressed / Analog modulation

DR-AN series modules are wideband RF amplifiers designed to drive optical modulators at frequencies up to 40 GHz.

MBC-DG-BT is continuously tunable : it can lock on any point of the modulator transfer curve, and adapt to a variety of applications.



Pulse ModBoxes are turnkey optical transmitters and benchtop modulation units for pulse applications. They can be tailored to specific pulse applications : generation, picking, splicing.

About us

Photline Technologies is a provider of Fiber Optics Modulation Solutions based on the company LiNb₃ modulators and high-speed electronics modules. Photline Technologies offers high speed and high data rate modulation solutions for the telecommunication industry and the defense, aerospace, instruments and sensors markets. The products offered by the company include : comprehensive range of intensity and phase modulators (800 nm, 1060 nm, 1300 nm, 1550 nm, 2000 nm), RF drivers and modules, transmitters and modulation units.

ZI Les Tilleroyes - Trépillot
16, rue Auguste Jouchoux - 25 000 Besançon - FRANCE
tél. : +33 (0) 381 853 180 - fax : + 33 (0) 381 811 557

InnoTech (주)에이이노텍 www.AINNOTECH.com
Email: korea@ainnotech.com
FiberAll www.FIBERALL.co.kr
광통신 전문 쇼핑몰! 파이버홀! 서울시 송파구 가락동 10-9 현성 B/D 2F

Photline Technologies reserves the right to change, at any time and without notice, the specifications, design, function or form of its products described herein. All statements, specification, technical information related to the products herein are given in good faith and based upon information believed to be reliable and accurate at the moment of printing. However the accuracy and completeness thereof is not guaranteed. No liability is assumed for any inaccuracies and as a result of use of the products. The user must validate all parameters for each application before use and he assumes all risks in connection with the use of the products.