



More Information at:



## laser processing made easy

SCANLAB's laserDESK<sup>®</sup> software lets you easily create and execute professional laser marking and material-processing programs (laser jobs). Its user-friendly interface provides all needed functionality, including setup and control of all your laser scan system components.

laserDESK<sup>®</sup> controls your hardware via SCANLAB's RTC<sup>®</sup>5 control boards. This means you'll also have user-interface access to the iDRIVE<sup>®</sup> functionality of SCANLAB's newest-generation scan heads.

As a system integrator, you gain equipment planning, assembly and maintenance advantages, because laserDESK<sup>®</sup> is perfectly tuned to SCANLAB's scan heads and RTC<sup>®</sup> control boards. Also SCANalign<sup>®</sup> is easy to integrate into the laserDESK<sup>®</sup> software. laserDESK<sup>®</sup>'s powerful functionality also helps you configure, test, calibrate and monitor the system components, thus simplifying integration into your production lines.

As a laser-job designer, you'll value how laserDESK<sup>®</sup> provides everything needed to create customized marking templates. Functions such as 3D marking are available, too. laserDESK<sup>®</sup>'s feature set and graphical interface are familiar to anyone who has used popular graphics programs. Process parameters can be individually assigned to any marking object. When creating and managing laser jobs, you'll benefit from library functions for reusing marking objects and parameter sets. Control elements integrate your system components and specify communication and synchronization between them. In production, your external control signals can thus also select alternate program sequences. This allows you to automate complex operations via simple functions.

laserDESK<sup>®</sup>'s high quality is the result of SCANLAB's years of experience developing and manufacturing scan systems and serving the laser material processing industry. The company's skilled software team ensures professionalism and continuous .NET-based development of the laserDESK<sup>®</sup> program.

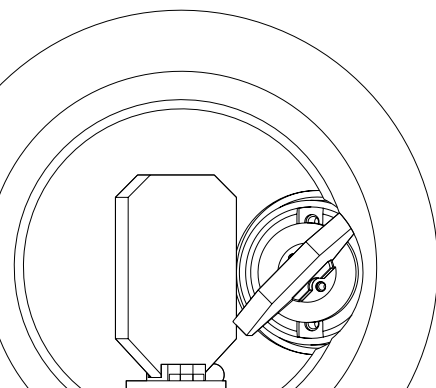

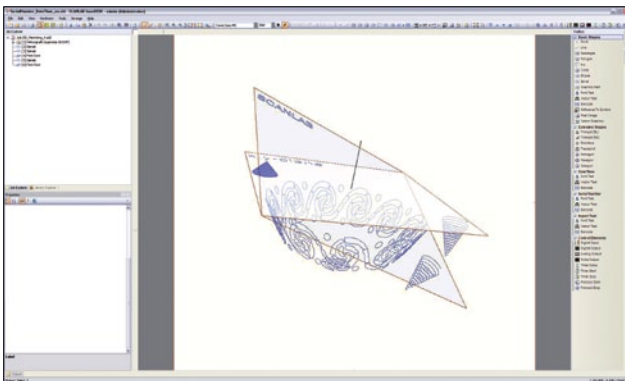
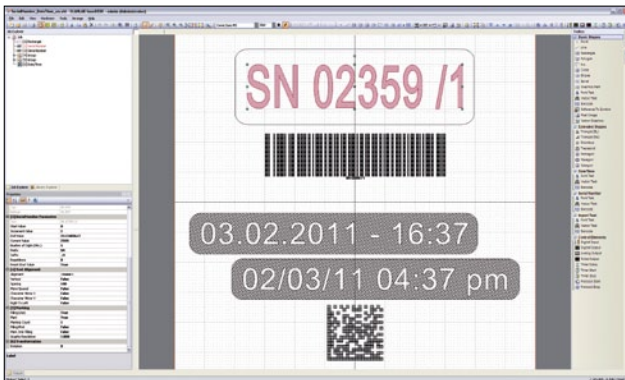
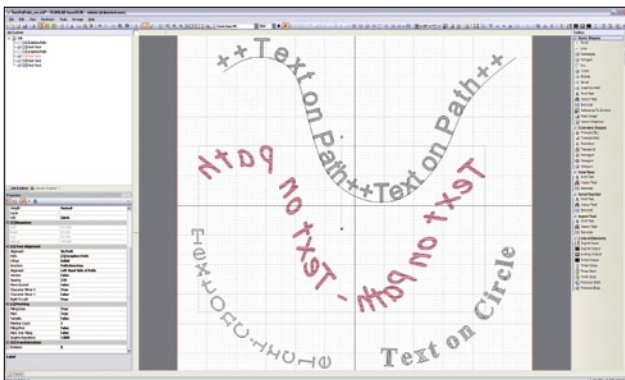
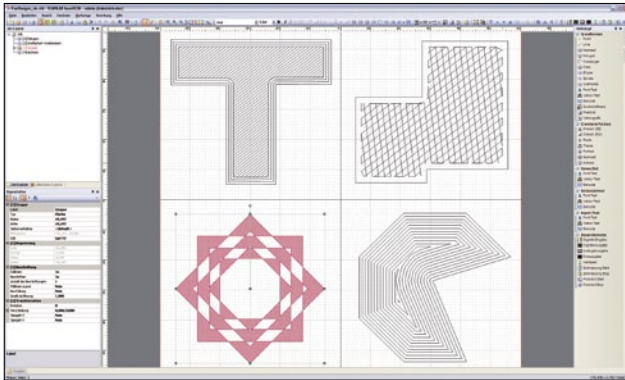

### Graphical User Interface (GUI)

laserDESK®'s user-friendly graphical user interface is individually configurable.

- Graphical creation and editing of marking objects
- Easy switching between various user interface modes for creating, testing and executing your marking processes
- Context-sensitive help (incl. dynamic help in laserDESK® program window)
- Language selectable (currently English, German and Chinese)
- Individually assignable user rights

### Marking Objects

Familiar tools let you easily create and edit a wide variety of geometric shapes.

- Drawing functions for creating graphic objects (e.g. ellipses, Bezier curves, polygons)
- Versatile fill functions, e.g.:
  - Path and/or hatch
  - One or several hatch levels
  - Outline settings
- Import filters for widely-used bitmap and vector-graphic formats (e.g. jpg, tiff, bmp, dxf, plt, ai); dxf importability includes 3D files
- Easy creation of text elements
  - Font and vector text, multiline text
  - All true type fonts supported
  - Easy support and creation of single stroke fonts
  - 1D and 2D barcodes
  - External text file import
  - Text alignment to paths and circles
  - Full Unicode support
- Functions for marking serial numbers and date/time
  - Individual formatting
  - Also as 1D and 2D barcodes
- Functions for 3D marking (e.g. 3D spirals, marking on inclined planes)

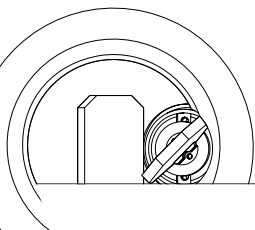

### Graphic and Process Parameters

- Easy-to-use editor for assigning graphic, marking, fill and bitmap parameters
- Library Explorer for managing:
  - User-defined marking objects
  - Re-use of individual marking objects and parameter sets
  - Editing of vector fonts
- Clearly structured, context-sensitive display of object properties
- Universal program library and individual job libraries

### Process Control

Process control via various signals is integrated:

- Freely positionable control elements
- Various control elements provided for communication with external equipment (e.g. digital signals, serial communication, image processing via a camera system)
- Marking variants selectable via input signals (RTC®5 board's ports)
- Logging of positioning data and timing
- Automatic Mode enables execution without any user interaction

### Remote Control (optional)

A remote control option allows control of laserDESK® from your control station via ethernet or a serial interface.

The following functions are remotely controllable:

- Job selection and transformation
- Definition of text content
- Job execution
- System diagnosis

This enables fully automatic control of laserDESK® without human intervention.

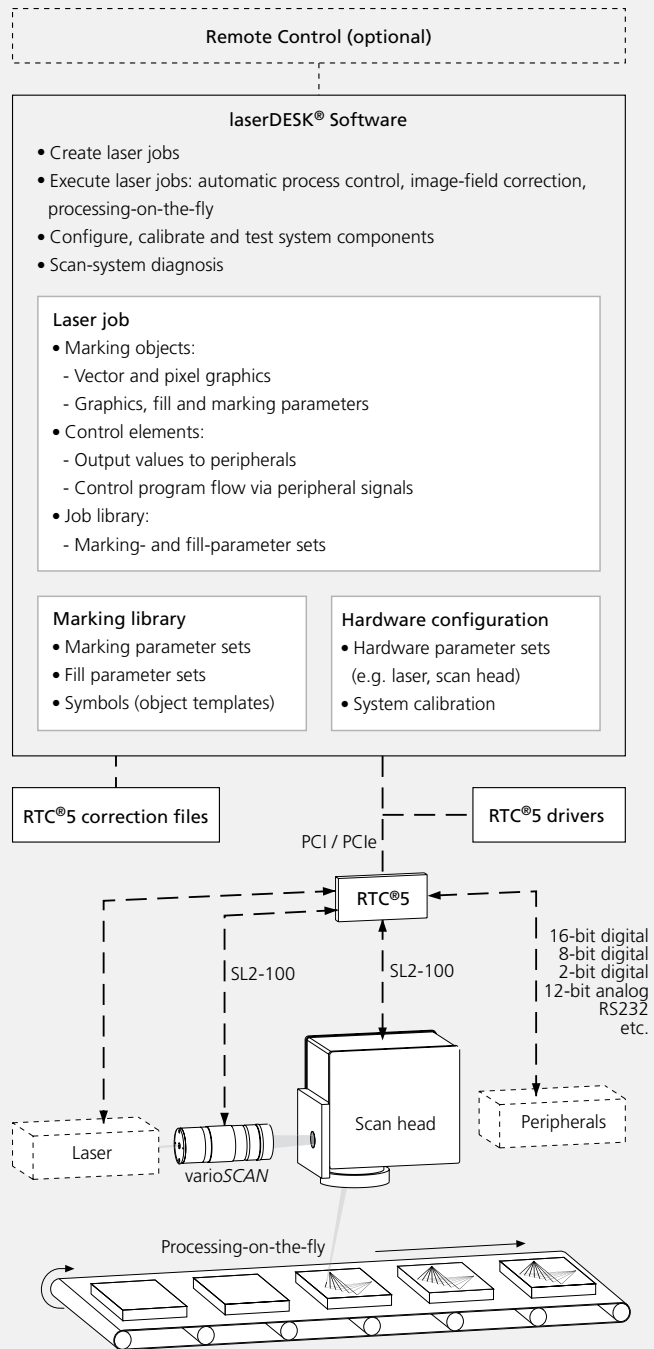

### Support of RTC®5 Functions

- Process control via the RTC®5's I/O ports without additional hardware or software
- Dynamic memory management of 1-MB RTC®5 memory
- Support of 2 connected scan heads
- Full support for a number of lasers without additional hardware or software
- Support of varioSCAN
- Marking of arcs via circle and ellipse functions
- 20-bit resolution scan head control
- 24-bit virtual image field for layout positioning when processing-on-the-fly
- Individually programmable sky writing
- Support of intelliSCAN® diagnostic functions
- Automatic integration of RTC®5 field correction data
- 3D functionality in conjunction with RTC®5 3D option and varioSCAN (requires activation of corresponding laserDESK® functions)

### Extension with SCANalign®

- SCANalign® is quick and easy to integrate
- The evaluation of image data is enabled:
  - Precise scanner calibration
  - Automatic alignment of scan patterns to fixtures and jigs
  - Compensation of scanner and/or system drift

### Hardware Configuration and Control

- Hardware calibration via assisted dialogs
- Pilot laser functions for easy marking alignment on the workpiece
- All hardware settings accessible in configuration window:
  - Processing laser and pilot laser
  - Optics
  - PC interfaces
  - Processing-on-the-fly (if option enabled on RTC®5)
  - Remote control interface
- Console for testing the signal transfer to/from RTC®5 board's IO ports

### Editions

- Several laserDESK® editions with different functional ranges are available (equal software but different dongle configurations)

### System Requirements

- IBM compatible PC with PCI or PCIe bus
- RTC®5 control board
- 32-bit operating system: Windows 7, Windows Vista or Windows XP with Framework 3.5
- USB port for laserDESK® dongle

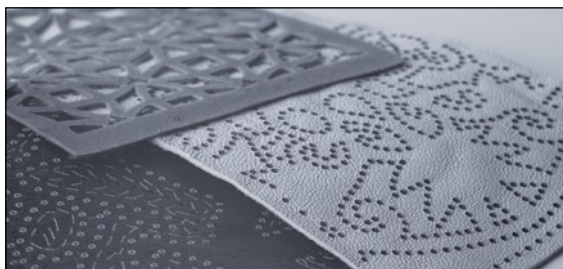
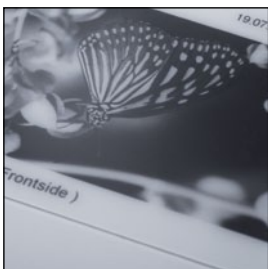

**www.AINNOTECH.com**  
Email: [korea@ainnotech.com](mailto:korea@ainnotech.com)  
TEL: 02.409.3222 FAX: 02.409.3229  
서울시 송파구 가락동 10-9 현성 B/D 2F